

ITEM TECHNICAL CARD

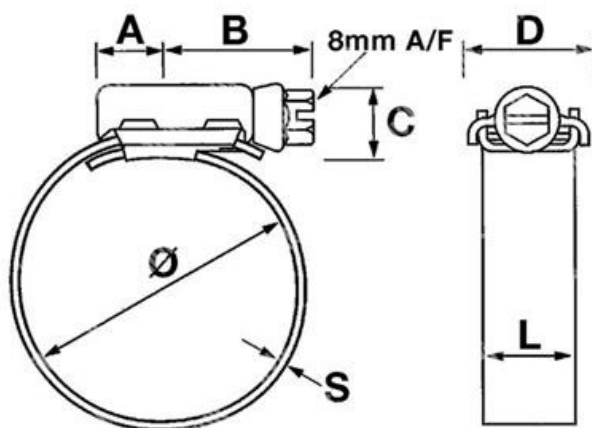

diametro pollici	8 1/4 - 9 1/2
tipo	HTJ240P
B (mm)	27,0
D (mm)	23,0
S (mm)	0,8
L (mm)	16,0
A (mm)	11,0
C (mm)	13,0
diametro (mm)	210 - 240
CS (mm)	15,0
misura	240,0

DESCRIZIONE \ DESCRIPTION: JCSW5-HITORQUE 240 Fascetta Inox 316 L.16mm 210-240		CATEGORIA \ CATEGORY: 4683000.00025	
MATERIAL \ MATERIAL:		TRATTAMENTO TERMICO \ HEAT TREATMENT:	NOTE \ NOTES:
ESEGUITO DA \ DRAWN BY: RIVIT	DATA:	TRATT. SUPERFICIALE \ SURF. TREATMENT:	Rugosità superficiale generale: General surface roughness:
CONTROLLATO DA \ CHECKED BY: RIVIT	DATA:	PROFONDITÀ TRATTAMENTO TERMICO (SURF) [mm]: HEAT TREATMENT (SURF) DEPTH [mm]:	NON SCALARE IL DISEGNO DO NOT RESIZE THE DRAW
APPROVATO DA \ APPROVED BY: RIVIT	DATA:	DUREZZA \ HARDNESS:	METODO 1 (ISO 128) METHOD 1 (ISO 128)
		PESO \ WEIGHT:	REVISIONE: REVISION:
		FOGLIO \ SHEET: 1 OF 1	CARTIGLIO \ FORMAT Mod.P023_07
		FORMATO FOGLIO: SHEET FORMAT: A4	



**FASTENERS
& TOOLS**
RIVIT.IT