

ITEM TECHNICAL CARD

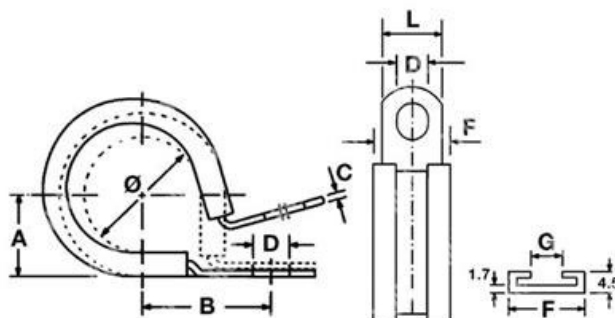

G (mm)	12,0
tipo	PESH048BG
B (mm)	42,0
D (mm)	10,8
F (mm)	23,0
L (mm)	20,0
A (mm)	28,0
C (mm)	0,7
misura	48,0

DESCRIZIONE \ DESCRIPTION: <b>JCS-PCLIPS M10-48 Fascetta antibib.inox 304 L.12mm M10-d.48</b>		CATEGORIA \ CATEGORY: <b>4679500.00025</b>	
MATERIAL \ MATERIAL:		TRATTAMENTO TERMICO \ HEAT TREATMENT:	NOTE \ NOTES:
ESEGUITO DA \ DRAWN BY: <b>RIVIT</b>	DATA:	TRATT. SUPERFICIALE \ SURF. TREATMENT:	Rugosità superficiale generale: General surface roughness:
CONTROLLATO DA \ CHECKED BY: <b>RIVIT</b>	DATA:	PROFONDITÀ TRATTAMENTO TERMICO (SURF) [mm]: HEAT TREATMENT (SURF) DEPTH [mm]:	<b>NON SCALARE IL DISEGNO DO NOT RESIZE THE DRAW</b>
APPROVATO DA \ APPROVED BY: <b>RIVIT</b>	DATA:	DUREZZA \ HARDNESS:	METODO 1 (ISO 128) METHOD 1 (ISO 128)
		PESO \ WEIGHT:	REVISIONE: REVISION:
		FOGLIO \ SHEET: <b>1 OF 1</b>	
		FORMATO FOGLIO: SHEET FORMAT: <b>A4</b>	
		CARTIGLIO \ FORMAT <b>Mod.P023_07</b>	



**FASTENERS  
& TOOLS**  
RIVIT.IT