

ITEM TECHNICAL CARD

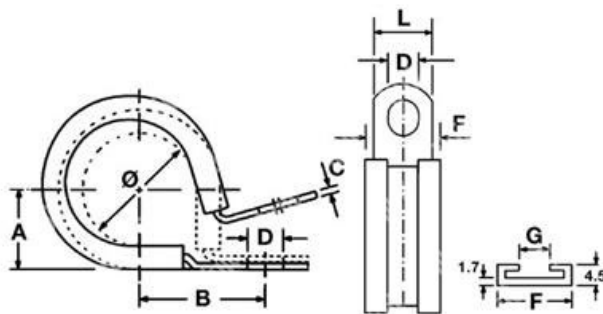

G (mm)	7,0
tipo	PCZ005BG
B (mm)	15,0
D (mm)	6,6
F (mm)	16,0
L (mm)	12,6
A (mm)	6,0
C (mm)	0,9
misura	5,0

DESCRIZIONE \ DESCRIPTION: <b>JCS-PCLIPS M6-5 Fascetta antivib.FEZ L.12mm M6-d.5</b>				CATEGORIA \ CATEGORY: <b>4674800.00050</b>	
MATERIAL \ MATERIAL:		TRATTAMENTO TERMICO \ HEAT TREATMENT:		NOTE \ NOTES:	
ESEGUITO DA \ DRAWN BY: <b>RIVIT</b>	DATA:	TRATT. SUPERFICIALE \ SURF. TREATMENT:	Rugosità superficiale generale: General surface roughness:		
CONTROLLATO DA \ CHECKED BY: <b>RIVIT</b>	DATA:	PROFONDITÀ TRATTAMENTO TERMICO (SURF) [mm]: HEAT TREATMENT (SURF) DEPTH [mm]:	<b>NON SCALARE IL DISEGNO DO NOT RESIZE THE DRAW</b>		
APPROVATO DA \ APPROVED BY: <b>RIVIT</b>	DATA:	DUREZZA \ HARDNESS:	FOGLIO \ SHEET: <b>1 OF 1</b>	FORMATO FOGLIO: SHEET FORMAT: <b>A4</b>	METODO 1 (ISO 128) METHOD 1 (ISO 128) REVISIONE: REVISION:
		PESO \ WEIGHT:	Scale \ SCALE:	CARTIGLIO \ FORMAT <b>Mod.P023_07</b>	



**FASTENERS  
& TOOLS**  
RIVIT.IT