

ITEM TECHNICAL CARD

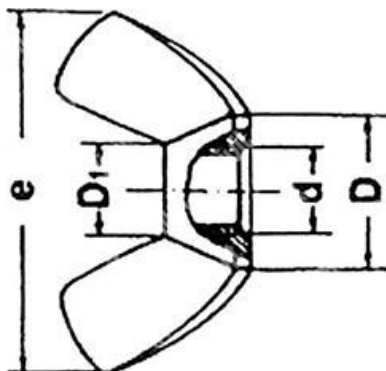

h (mm)	14,8
Materiale	acciaio grezzo cl.8
Diametro	M8
passo	1,25
UNI	5548
DIN	315A
Descr. Normativa	dadi ad alette
e (mm)	30,3
d1 (mm)	13,8
d2 (mm)	5,6

DESCRIZIONE \ DESCRIPTION: Dado ad Alette UNI 5448/DIN 315 AM. TYPE cl.8 GR M8				CATEGORIA \ CATEGORY: 24156GR	
MATERIAL \ MATERIAL:		TRATTAMENTO TERMICO \ HEAT TREATMENT:		NOTE \ NOTES:	
ESEGUITO DA \ DRAWN BY: RIVIT	DATA:	TRATT. SUPERFICIALE \ SURF. TREATMENT:	Rugosità superficiale generale: General surface roughness:		
CONTROLLATO DA \ CHECKED BY: RIVIT	DATA:	PROFONDITÀ TRATTAMENTO TERMICO (SURF) [mm]: HEAT TREATMENT (SURF) DEPTH [mm]:	NON SCALARE IL DISEGNO DO NOT RESIZE THE DRAW		
APPROVATO DA \ APPROVED BY: RIVIT	DATA:	DUREZZA \ HARDNESS:	FOGLIO \ SHEET: 1 OF 1	FORMATO FOGLIO: SHEET FORMAT: A4	METODO 1 (ISO 128) METHOD 1 (ISO 128) REVISIONE: REVISION:
		PESO \ WEIGHT:	Scale \ SCALE:	CARTIGLIO \ FORMAT Mod.P023_07	



**FASTENERS
& TOOLS**
RIVIT.IT