

ITEM TECHNICAL CARD

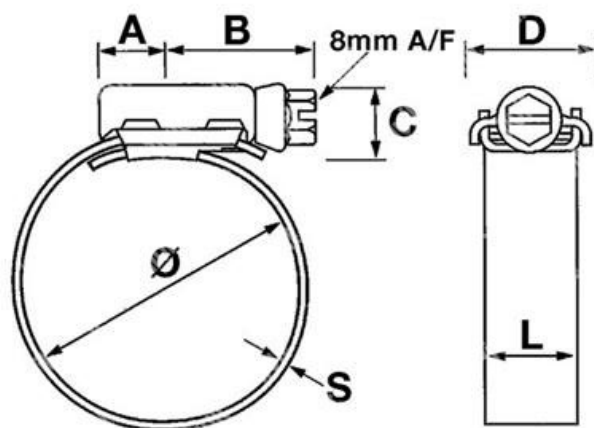

diametro pollici	1 5/8 - 2 3/8
typologie	HTJ060P
B (mm)	27,0
D (mm)	23,0
S (mm)	0,8
L (mm)	16,0
A (mm)	11,0
C (mm)	13,0
diamètre (mm)	40 - 60
CS (mm)	15,0
misura	60,0

DESCRIZIONE \ DESCRIPTION: JCSW5-HITORQUE 60 Colliers Inox 316 L.13mm 40-60			CATEGORIA \ CATEGORY: 4681900.00100	
MATERIAL \ MATERIAL:		TRATTAMENTO TERMICO \ HEAT TREATMENT:		NOTE \ NOTES:
ESEGUITO DA \ DRAWN BY: RIVIT	DATA:	TRATT. SUPERFICIALE \ SURF. TREATMENT:	Rugosità superficiale generale: General surface roughness:	
CONTROLLATO DA \ CHECKED BY: RIVIT	DATA:	PROFONDITÀ TRATTAMENTO TERMICO (SURF) [mm]: HEAT TREATMENT (SURF) DEPTH [mm]:		NON SCALARE IL DISEGNO DO NOT RESIZE THE DRAW
APPROVATO DA \ APPROVED BY: RIVIT	DATA:	DUREZZA \ HARDNESS:	FOGLIO \ SHEET: 1 OF 1	
		PESO \ WEIGHT:	Scale \ SCALE:	METODO 1 (ISO 128) METHOD 1 (ISO 128)
			CARTIGLIO \ FORMAT Mod.P023_07	REVISIONE: REVISION:



**FASTENERS
& TOOLS**
RIVIT.IT