

ITEM TECHNICAL CARD

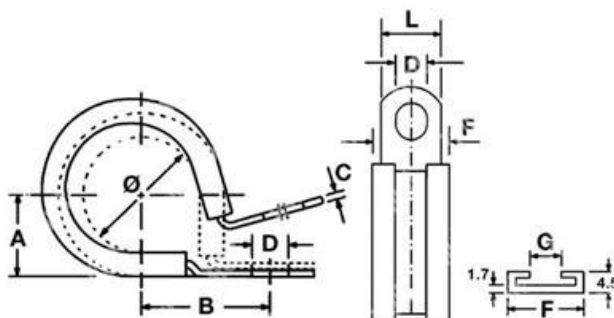

G (mm)	12,0
typologie	PESH019BG
B (mm)	28,0
D (mm)	10,8
F (mm)	23,0
L (mm)	20,0
A (mm)	13,0
C (mm)	0,7
misura	19,0

DESCRIZIONE \ DESCRIPTION: JCS-PCLIPS M10-19 Collier antivib. Inox 304 L.12mm M10-d.19		CATEGORIA \ CATEGORY: 4678400.00025	
MATERIAL \ MATERIAL:		TRATTAMENTO TERMICO \ HEAT TREATMENT:	NOTE \ NOTES:
ESEGUITO DA \ DRAWN BY: RIVIT	DATA:	TRATT. SUPERFICIALE \ SURF. TREATMENT:	Rugosità superficiale generale: General surface roughness:
CONTROLLATO DA \ CHECKED BY: RIVIT	DATA:	PROFONDITÀ TRATTAMENTO TERMICO (SURF) [mm]: HEAT TREATMENT (SURF) DEPTH [mm]:	NON SCALARE IL DISEGNO DO NOT RESIZE THE DRAW
APPROVATO DA \ APPROVED BY: RIVIT	DATA:	DUREZZA \ HARDNESS:	METODO 1 (ISO 128) REVISIONE: METHOD 1 (ISO 128) REVISION:
		PESO \ WEIGHT:	CARTIGLIO \ FORMAT Mod.P023_07
		FOGLIO \ SHEET: 1 OF 1	FORMATO FOGLIO: SHEET FORMAT: A4
		Scale \ SCALE:	



**FASTENERS
& TOOLS**
RIVIT.IT