

ITEM TECHNICAL CARD

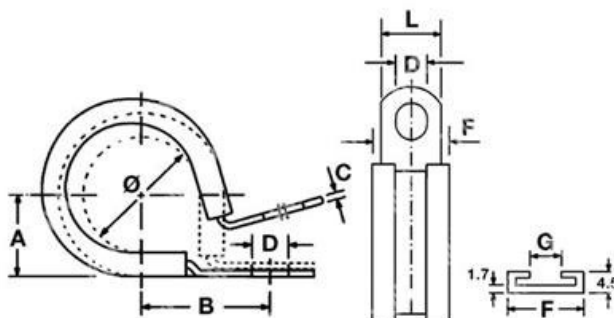

G (mm)	7,0
typologie	PCS013BG
B (mm)	20,0
D (mm)	6,6
F (mm)	16,0
L (mm)	12,6
A (mm)	10,0
C (mm)	0,9
misura	13,0

DESCRIZIONE \ DESCRIPTION: JCS-PCLIPS M6-13 Collier antivibrante Inox304L. 12mm M6-d.13				CATEGORIA \ CATEGORY: 4676700.00025	
MATERIAL \ MATERIAL:		TRATTAMENTO TERMICO \ HEAT TREATMENT:		NOTE \ NOTES:	
ESEGUITO DA \ DRAWN BY: RIVIT	DATA:	TRATT. SUPERFICIALE \ SURF. TREATMENT:	Rugosità superficiale generale: General surface roughness:		
CONTROLLATO DA \ CHECKED BY: RIVIT	DATA:	PROFONDITÀ TRATTAMENTO TERMICO (SURF) [mm]: HEAT TREATMENT (SURF) DEPTH [mm]:	NON SCALARE IL DISEGNO DO NOT RESIZE THE DRAW		
APPROVATO DA \ APPROVED BY: RIVIT	DATA:	DUREZZA \ HARDNESS:	FOGLIO \ SHEET: 1 OF 1	FORMATO FOGLIO: SHEET FORMAT: A4	METODO 1 (ISO 128) METHOD 1 (ISO 128) REVISIONE: REVISION:
		PESO \ WEIGHT:	Scale \ SCALE:	CARTIGLIO \ FORMAT Mod.P023_07	



**FASTENERS
& TOOLS**
RIVIT.IT