

ITEM TECHNICAL CARD

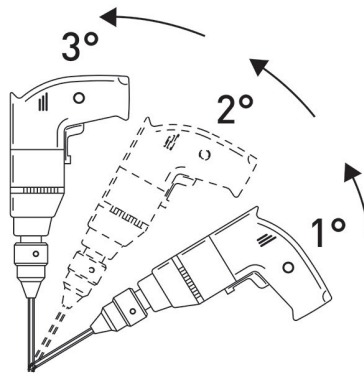

model

P034/06S

DESCRIZIONE \ DESCRIPTION: FERVI-M14 Diamond drill bit and core drill w/ continuos edge Set				CATEGORIA \ CATEGORY: 6257900	
MATERIALE \ MATERIAL:		TRATTAMENTO TERMICO \ HEAT TREATMENT:		NOTE \ NOTES:	
ESEGUITO DA \ DRAWN BY: RIVIT	DATA:	TRATT. SUPERFICIALE \ SURF. TREATMENT:	Rugosità superficiale generale: General surface roughness:		
CONTROLLATO DA \ CHECKED BY: RIVIT	DATA:	PROFONDITÀ TRATTAMENTO TERMICO (SURF) [mm]: HEAT TREATMENT (SURF) DEPTH [mm]:	NON SCALARE IL DISEGNO DO NOT RESIZE THE DRAW		
APPROVATO DA \ APPROVED BY: RIVIT	DATA:	DUREZZA \ HARDNESS:	FOGLIO \ SHEET: 1 OF 1	FORMATO FOGLIO: SHEET FORMAT: A4	METODO 1 (ISO 128) METHOD 1 (ISO 128) REVISIONE: REVISION:
		PESO \ WEIGHT:	Scale \ SCALE:	CARTIGLIO \ FORMAT Mod.P023_07	



**FASTENERS
& TOOLS**
RIVIT.IT