

ITEM TECHNICAL CARD

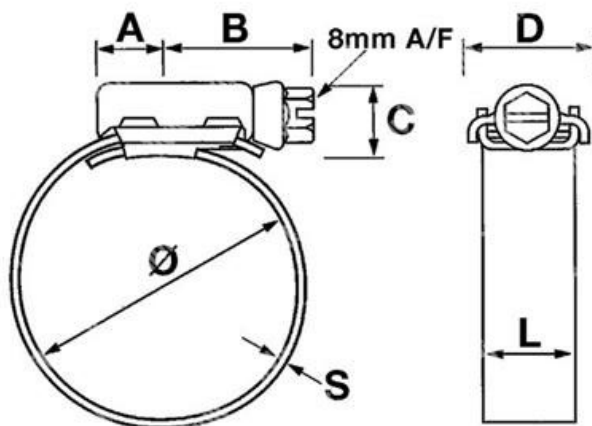

diametro pollici	8 1/4 - 9 1/2
model	HTJ240P
B (mm)	27,0
D (mm)	23,0
S (mm)	0,8
L (mm)	16,0
A (mm)	11,0
C (mm)	13,0
diameter (mm)	210 - 240
CS (mm)	15,0
misura	240,0

DESCRIZIONE \ DESCRIPTION: JCS-HITORQUE 240 316-Stainless ST hose clips L.13mm 210-240		CATEGORIA \ CATEGORY: 4683000.00025	
MATERIAL \ MATERIAL:		TRATTAMENTO TERMICO \ HEAT TREATMENT:	
ESEGUITO DA \ DRAWN BY: RIVIT		NOTE \ NOTES:	
DATA:	TRATT. SUPERFICIALE \ SURF. TREATMENT:	Rugosità superficiale generale: General surface roughness:	
CONTROLLATO DA \ CHECKED BY: RIVIT	DATA:	PROFONDITÀ TRATTAMENTO TERMICO (SURF) [mm]: HEAT TREATMENT (SURF) DEPTH [mm]:	NON SCALARE IL DISEGNO DO NOT RESIZE THE DRAW
APPROVATO DA \ APPROVED BY: RIVIT	DATA:	DUREZZA \ HARDNESS:	FUOGIO \ SHEET: 1 OF 1
		PESO \ WEIGHT:	FORMATO FOGGIO: A4
		Scale \ SCALE:	METODO 1 (ISO 128) METHOD 1 (ISO 128)
			REVISIONE: REVISION:
			CARTIGLIO \ FORMAT Mod.P023_07



**FASTENERS
& TOOLS**
RIVIT.IT