

ITEM TECHNICAL CARD

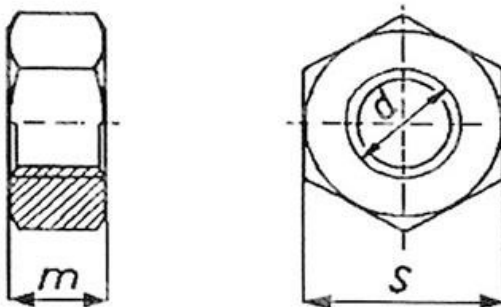

Material	white zinc plated steel cl.8
Diameter	M7
pitch	1,0
UNI	5587
DIN	267
ISO	4033
m (mm)	7,0
S (mm)	11,0
Rules Description	hexagon nuts

DESCRIZIONE \ DESCRIPTION: <b>Hexagon nut UNI 5587 cl.8 - white zinc plated steel M7</b>				CATEGORIA \ CATEGORY: <b>22117ZB</b>	
MATERIAL \ MATERIAL:		TRATTAMENTO TERMICO \ HEAT TREATMENT:		NOTE \ NOTES:	
ESEGUITO DA \ DRAWN BY: <b>RIVIT</b>	DATA:	TRATT. SUPERFICIALE \ SURF. TREATMENT:	Rugosità superficiale generale: General surface roughness:		
CONTROLLATO DA \ CHECKED BY: <b>RIVIT</b>	DATA:	PROFONDITÀ TRATTAMENTO TERMICO (SURF) [mm]: HEAT TREATMENT (SURF) DEPTH [mm]:	<b>NON SCALARE IL DISEGNO DO NOT RESIZE THE DRAW</b>		
APPROVATO DA \ APPROVED BY: <b>RIVIT</b>	DATA:	DUREZZA \ HARDNESS:	FOGLIO \ SHEET: <b>1 OF 1</b>	FORMATO FOGLIO: SHEET FORMAT: <b>A4</b>	METODO 1 (ISO 128) METHOD 1 (ISO 128) REVISIONE: REVISION:
		PESO \ WEIGHT:	Scale \ SCALE:	CARTIGLIO \ FORMAT <b>Mod.P023_07</b>	



**FASTENERS  
& TOOLS**  
RIVIT.IT