

ITEM TECHNICAL CARD

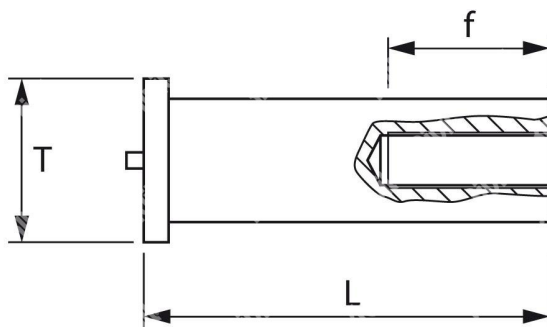

L - länge (mm)	6
Modell	BFX03006
T (mm)	6,5
Gewinde	M3
d. (mm)	5,0

DESCRIZIONE \ DESCRIPTION: BFX-Welding threaded bush Stainless steel /				CATEGORIA \ CATEGORY: 4763600.01000	
MATERIAL \ MATERIAL:		TRATTAMENTO TERMICO \ HEAT TREATMENT:		NOTE \ NOTES:	
ESEGUITO DA \ DRAWN BY: RIVIT	DATA:	TRATT. SUPERFICIALE \ SURF. TREATMENT:			
CONTROLLATO DA \ CHECKED BY: RIVIT		PROFONDITÀ TRATTAMENTO TERMICO (SURF) [mm]: HEAT TREATMENT (SURF) DEPTH [mm]:		NON SCALARE IL DISEGNO DO NOT RESIZE THE DRAW	
APPROVATO DA \ APPROVED BY: RIVIT		DUREZZA \ HARDNESS:	FOGLIO \ SHEET: 1 OF 1	FORMATO FOGLIO: SHEET FORMAT: A4	METODO 1 (ISO 128) METHOD 1 (ISO 128)
		PESO \ WEIGHT:	Scale \ SCALE:	CARTIGLIO \ FORMAT Mod.P023_07	REVISIONE: REVISION:
				FASTENERS & TOOLS RIVIT.IT	