

ITEM TECHNICAL CARD

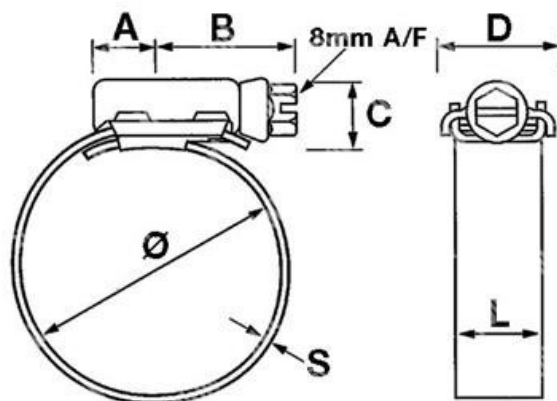

diametro pollici	3 1/2 - 4 3/4
Modell	HTM120P
B (mm)	27,0
D (mm)	23,0
S (mm)	0,8
L (mm)	16,0
A (mm)	11,0
C (mm)	13,0
Durchmesser (mm)	90 - 120
CS (mm)	15,0
misura	120,0

DESCRIZIONE \ DESCRIPTION: JCS-HITORQUE 120 304-Stainless ST hose clips L.13mm 90-120		CATEGORIA \ CATEGORY: 4684400.00050	
MATERIAL \ MATERIAL:		TRATTAMENTO TERMICO \ HEAT TREATMENT:	NOTE \ NOTES:
ESEGUITO DA \ DRAWN BY: RIVIT	DATA:	TRATT. SUPERFICIALE \ SURF. TREATMENT:	Rugosità superficiale generale: General surface roughness:
CONTROLLATO DA \ CHECKED BY: RIVIT	DATA:	PROFONDITÀ TRATTAMENTO TERMICO (SURF) [mm]: HEAT TREATMENT (SURF) DEPTH [mm]:	NON SCALARE IL DISEGNO DO NOT RESIZE THE DRAW
APPROVATO DA \ APPROVED BY: RIVIT	DATA:	DUREZZA \ HARDNESS:	METODO 1 (ISO 128) METHOD 1 (ISO 128)
		PESO \ WEIGHT:	REVISIONE: REVISION:
		FOGLIO \ SHEET: 1 OF 1	CARTIGLIO \ FORMAT Mod.P023_07
		FORMATO FOGLIO: SHEET FORMAT: A4	



**FASTENERS
& TOOLS**
RIVIT.IT