

ITEM TECHNICAL CARD

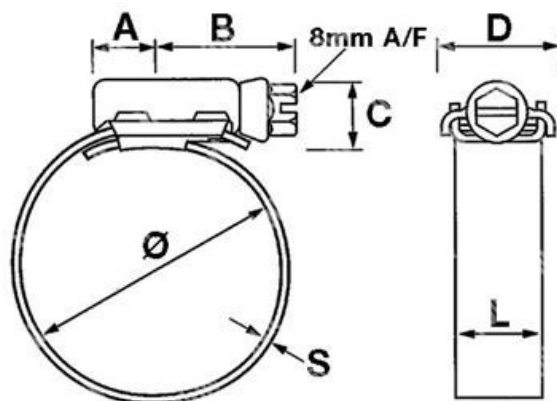

diametro pollici	3/4 - 1 3/8
Modell	HTM035P
B (mm)	27,0
D (mm)	23,0
S (mm)	0,8
L (mm)	16,0
A (mm)	11,0
C (mm)	13,0
Durchmesser (mm)	20 - 35
CS (mm)	15,0
misura	35,0

DESCRIZIONE \ DESCRIPTION: JCS-HITORQUE 35 304-Stainless ST hose clips L.13mm 20-35				CATEGORIA \ CATEGORY: 4683600.00100	
MATERIAL \ MATERIAL:		TRATTAMENTO TERMICO \ HEAT TREATMENT:		NOTE \ NOTES:	
ESEGUITO DA \ DRAWN BY: RIVIT	DATA:	TRATT. SUPERFICIALE \ SURF. TREATMENT:	Rugosità superficiale generale: General surface roughness:		
CONTROLLATO DA \ CHECKED BY: RIVIT	DATA:	PROFONDITÀ TRATTAMENTO TERMICO (SURF) [mm]: HEAT TREATMENT (SURF) DEPTH [mm]:	NON SCALARE IL DISEGNO DO NOT RESIZE THE DRAW		
APPROVATO DA \ APPROVED BY: RIVIT	DATA:	DUREZZA \ HARDNESS:	FOGLIO \ SHEET: 1 OF 1	FORMATO FOGLIO: SHEET FORMAT: A4	METODO 1 (ISO 128) METHOD 1 (ISO 128) REVISIONE: REVISION:
		PESO \ WEIGHT:	Scale \ SCALE:	CARTIGLIO \ FORMAT Mod.P023_07	



**FASTENERS
& TOOLS**
RIVIT.IT