

ITEM TECHNICAL CARD

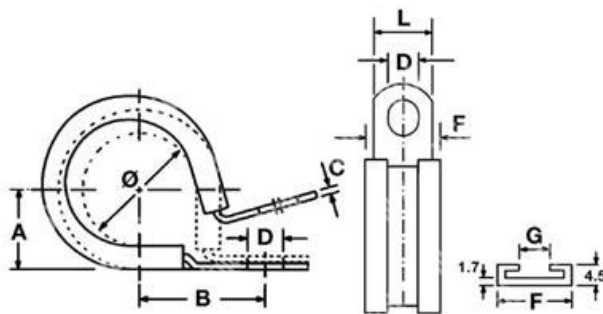

G (mm)	7,0
Modell	PCZ005BG
B (mm)	15,0
D (mm)	6,6
F (mm)	16,0
L (mm)	12,6
A (mm)	6,0
C (mm)	0,9
misura	5,0

DESCRIZIONE \ DESCRIPTION: JCS-M6-5 Vibration-dumping ST hose clip L.12mm M6-d.5		CATEGORIA \ CATEGORY: 4674800.00050	
MATERIAL \ MATERIAL:		TRATTAMENTO TERMICO \ HEAT TREATMENT:	NOTE \ NOTES:
ESEGUITO DA \ DRAWN BY: RIVIT	DATA:	TRATT. SUPERFICIALE \ SURF. TREATMENT:	Rugosità superficiale generale: General surface roughness:
CONTROLLATO DA \ CHECKED BY: RIVIT	DATA:	PROFONDITÀ TRATTAMENTO TERMICO (SURF) [mm]: HEAT TREATMENT (SURF) DEPTH [mm]:	NON SCALARE IL DISEGNO DO NOT RESIZE THE DRAW
APPROVATO DA \ APPROVED BY: RIVIT	DATA:	DUREZZA \ HARDNESS:	METODO 1 (ISO 128) METHOD 1 (ISO 128)
		PESO \ WEIGHT:	REVISIONE: REVISION:
		FOGLIO \ SHEET: 1 OF 1	
		FORMATO FOGLIO: SHEET FORMAT: A4	
		CARTIGLIO \ FORMAT Mod.P023_07	



**FASTENERS
& TOOLS**
RIVIT.IT