

ITEM TECHNICAL CARD

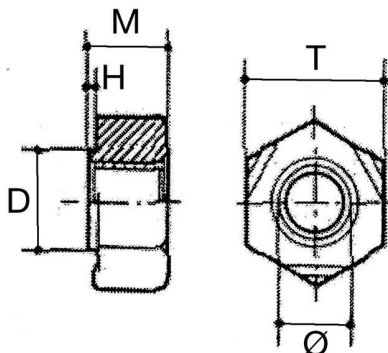

Material	Rohstahl kl.8
Durchmesser	M16
pitch	2,0
DIN	929
m (mm)	13,0
S (mm)	24,0
Normative Beschreibung	Sechskant Schweißmutter
e min (mm)	26,51

DESCRIZIONE \ DESCRIPTION: Sechskant Schweißmutter DIN 929 Kl.8 - Rohstahl M16				CATEGORIA \ CATEGORY: 3238500.00100	
MATERIAL \ MATERIAL:		TRATTAMENTO TERMICO \ HEAT TREATMENT:		NOTE \ NOTES:	
ESEGUITO DA \ DRAWN BY: RIVIT	DATA:	TRATT. SUPERFICIALE \ SURF. TREATMENT:	Rugosità superficiale generale: General surface roughness:	NON SCALARE IL DISEGNO DO NOT RESIZE THE DRAW	
CONTROLLATO DA \ CHECKED BY: RIVIT	DATA:	PROFONDITÀ TRATTAMENTO TERMICO (SURF) [mm]: HEAT TREATMENT (SURF) DEPTH [mm]:			
APPROVATO DA \ APPROVED BY: RIVIT	DATA:	DUREZZA \ HARDNESS:	FOGLIO \ SHEET: 1 OF 1	FORMATO FOGLIO: SHEET FORMAT: A4	METODO 1 (ISO 128) METHOD 1 (ISO 128)
		PESO \ WEIGHT:	Scale \ SCALE:	CARTIGLIO \ FORMAT Mod.P023_07	REVISIONE: REVISION:



**FASTENERS
& TOOLS**
RIVIT.IT