

ITEM TECHNICAL CARD

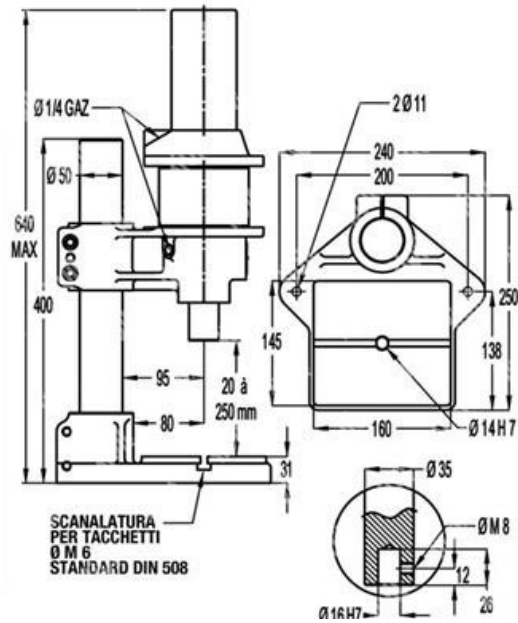

nutzbare Höhe (mm)	20 - 250
Hub (mm)	0 - 50
Macht (kg/f)	360
Gewicht (kg)	25
Modell	PHR6-2
Halstiefe (mm)	95

DESCRIZIONE \ DESCRIPTION: EMG-Pressetta pneumatica 360Kgf PHR6/2		CATEGORIA \ CATEGORY: 2987600	
MATERIAL \ MATERIAL:		TRATTAMENTO TERMICO \ HEAT TREATMENT:	NOTE \ NOTES:
ESEGUITO DA \ DRAWN BY: RIVIT	DATA:	TRATT. SUPERFICIALE \ SURF. TREATMENT:	Rugosità superficiale generale: General surface roughness:
CONTROLLATO DA \ CHECKED BY: RIVIT	DATA:	PROFONDITÀ TRATTAMENTO TERMICO (SURF) [mm]: HEAT TREATMENT (SURF) DEPTH [mm]:	NON SCALARE IL DISEGNO DO NOT RESIZE THE DRAW
APPROVATO DA \ APPROVED BY: RIVIT	DATA:	DUREZZA \ HARDNESS:	FUOGGIO \ SHEET: 1 OF 1
		PESO \ WEIGHT:	FORMATO FOGGIO: A4
		Scale \ SCALE:	METODO 1 (ISO 128) REVISIONE: METHOD 1 (ISO 128) REVISION:
			CARTIGLIO \ FORMAT Mod.P023_07



FASTENERS & TOOLS
RIVIT.IT