

ITEM TECHNICAL CARD

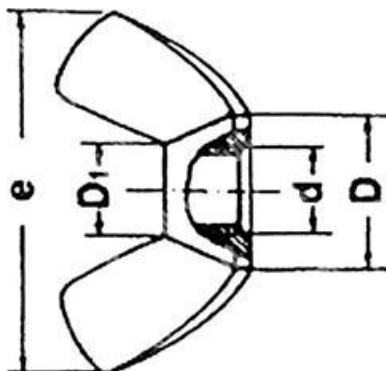

h (mm)	14,8
Material	Rohstahl kl.8
Durchmesser	M8
pitch	1,25
UNI	5548
DIN	315A
Normative Beschreibung	Flügelmutter
e (mm)	30,3
d1 (mm)	13,8
d2 (mm)	5,6

DESCRIZIONE \ DESCRIPTION: Flügelmutter U5448/D315 - Amerikanische Form cl.8 - Rohstahl M8		CATEGORIA \ CATEGORY: 24156GR	
MATERIAL \ MATERIAL:		TRATTAMENTO TERMICO \ HEAT TREATMENT:	NOTE \ NOTES:
ESEGUITO DA \ DRAWN BY: RIVIT	DATA:	TRATT. SUPERFICIALE \ SURF. TREATMENT:	Rugosità superficiale generale: General surface roughness:
CONTROLLATO DA \ CHECKED BY: RIVIT	DATA:	PROFONDITÀ TRATTAMENTO TERMICO (SURF) [mm]: HEAT TREATMENT (SURF) DEPTH [mm]:	NON SCALARE IL DISEGNO DO NOT RESIZE THE DRAW
APPROVATO DA \ APPROVED BY: RIVIT	DATA:	DUREZZA \ HARDNESS:	METODO 1 (ISO 128) METHOD 1 (ISO 128)
		FOGLIO \ SHEET: 1 OF 1	REVISIONE: REVISION:
		PESO \ WEIGHT:	CARTIGLIO \ FORMAT Mod.P023_07
		Scale \ SCALE:	



**FASTENERS
& TOOLS**
RIVIT.IT