

ITEM TECHNICAL CARD

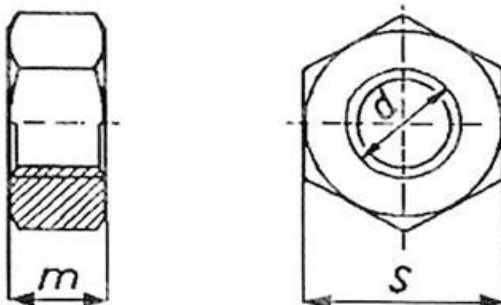

Material	Rohstahl kl.8
Durchmesser	M18
pitch	1,5
UNI	5587
DIN	267
ISO	4033
m (mm)	18,0
S (mm)	27,0
Normative Beschreibung	Hohe Selbstsichernde Sechskantmutter mit Polyamidring

DESCRIZIONE \ DESCRIPTION: Sechskantmutter UNI 5587 Fein Kl.8 - Rohstahl M18x1,50				CATEGORIA \ CATEGORY: 22109GR	
MATERIAL \ MATERIAL:		TRATTAMENTO TERMICO \ HEAT TREATMENT:		NOTE \ NOTES:	
ESEGUITO DA \ DRAWN BY: RIVIT	DATA:	TRATT. SUPERFICIALE \ SURF. TREATMENT:	Rugosità superficiale generale: General surface roughness:		
CONTROLLATO DA \ CHECKED BY: RIVIT	DATA:	PROFONDITÀ TRATTAMENTO TERMICO (SURF) [mm]: HEAT TREATMENT (SURF) DEPTH [mm]:	NON SCALARE IL DISEGNO DO NOT RESIZE THE DRAW		
APPROVATO DA \ APPROVED BY: RIVIT	DATA:	DUREZZA \ HARDNESS:	FOGLIO \ SHEET: 1 OF 1	FORMATO FOGLIO: SHEET FORMAT: A4	METODO 1 (ISO 128) METHOD 1 (ISO 128) REVISIONE: REVISION:
		PESO \ WEIGHT:	Scale \ SCALE:	CARTIGLIO \ FORMAT Mod.P023_07	



**FASTENERS
& TOOLS**
RIVIT.IT